



US0D1047947S

(12) **United States Design Patent**
Park et al.

(10) **Patent No.:** **US D1,047,947 S**
(45) **Date of Patent:** **** Oct. 22, 2024**

(54) **ELECTRONIC DEVICE**
(71) Applicant: **Samsung Electronics Co., Ltd.**,
Suwon-si (KR)
(72) Inventors: **Seonkeun Park**, Suwon-si (KR);
Jaewoong Chung, Suwon-si (KR);
Duyeong Choi, Suwon-si (KR); **Ethan**
Lee, Suwon-si (KR)

D593,525 S * 6/2009 Wang D14/138 G
D594,437 S * 6/2009 Kim D14/138 AC
D616,408 S * 5/2010 Wang D14/203.7
D654,464 S * 2/2012 Han D14/138 G
D665,763 S * 8/2012 Tsai D14/138 G
D714,751 S * 10/2014 Kim D14/138 G
D790,496 S * 6/2017 Park D14/138 AA
D829,186 S * 9/2018 Kim D14/138 G
D958,769 S * 7/2022 Ji D14/138 AD
D960,854 S * 8/2022 Ji D14/138 AD
D960,855 S * 8/2022 Ji D14/138 AD

(73) Assignee: **SAMSUNG ELECTRONICS CO., LTD.**, Gyeonggi-do (KR)

FOREIGN PATENT DOCUMENTS

(**) Term: **15 Years**

WO D227955-008 * 3/2024
WO D227955-009 * 3/2024
WO D227955-010 * 3/2024
WO D227955-011 * 3/2024
WO D227955-012 * 3/2024

(21) Appl. No.: **29/888,163**

* cited by examiner

(22) Filed: **Mar. 28, 2023**

(30) **Foreign Application Priority Data**

Primary Examiner — Bridget L Eland
(74) *Attorney, Agent, or Firm* — CANTOR COLBURN
LLP

Sep. 30, 2022 (KR) 30-2022-0040190

(51) **LOC (14) Cl.** **14-03**

(52) **U.S. Cl.** **D14/138 G**

(58) **Field of Classification Search**

USPC D14/138 G, 138 AD, 138 AB, 248, 341,
D14/345, 439, 432, 371, 374, 138 R,
D14/138 AA, 138 AC, 138 C
CPC H04M 1/0202; H04M 1/0235; H04M
1/0237; H04M 1/0239; H04M 1/0266;
H04M 1/0268; H04M 1/027; H04M
1/0295; H04M 1/02; H04M 1/0279;
H04M 1/0283

See application file for complete search history.

(56) **References Cited**

U.S. PATENT DOCUMENTS

D541,785 S * 5/2007 Hwang D14/138 G
D560,194 S * 1/2008 Song D14/138 AB

(57) **CLAIM**

The ornamental design for an electronic device, as shown and described.

DESCRIPTION

FIG. 1 is a front perspective view of an electronic device, showing our new design;
FIG. 2 is a front view thereof;
FIG. 3 is a rear view thereof;
FIG. 4 is a left-side view thereof;
FIG. 5 is a right-side view thereof;
FIG. 6 is a top view thereof;
FIG. 7 is a bottom view thereof; and,
FIG. 8 is a rear perspective view thereof.
The broken lines in the figures depict portions of an electronic device that form no part of the claimed design.

1 Claim, 6 Drawing Sheets

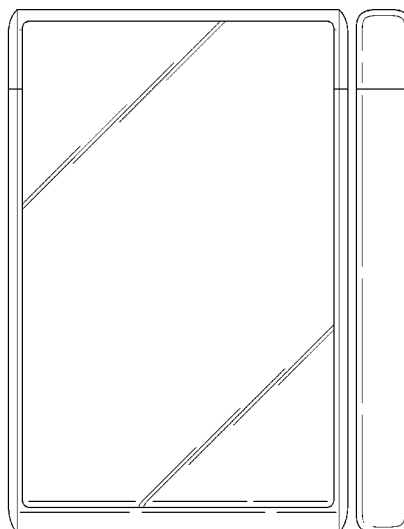

FIG. 1

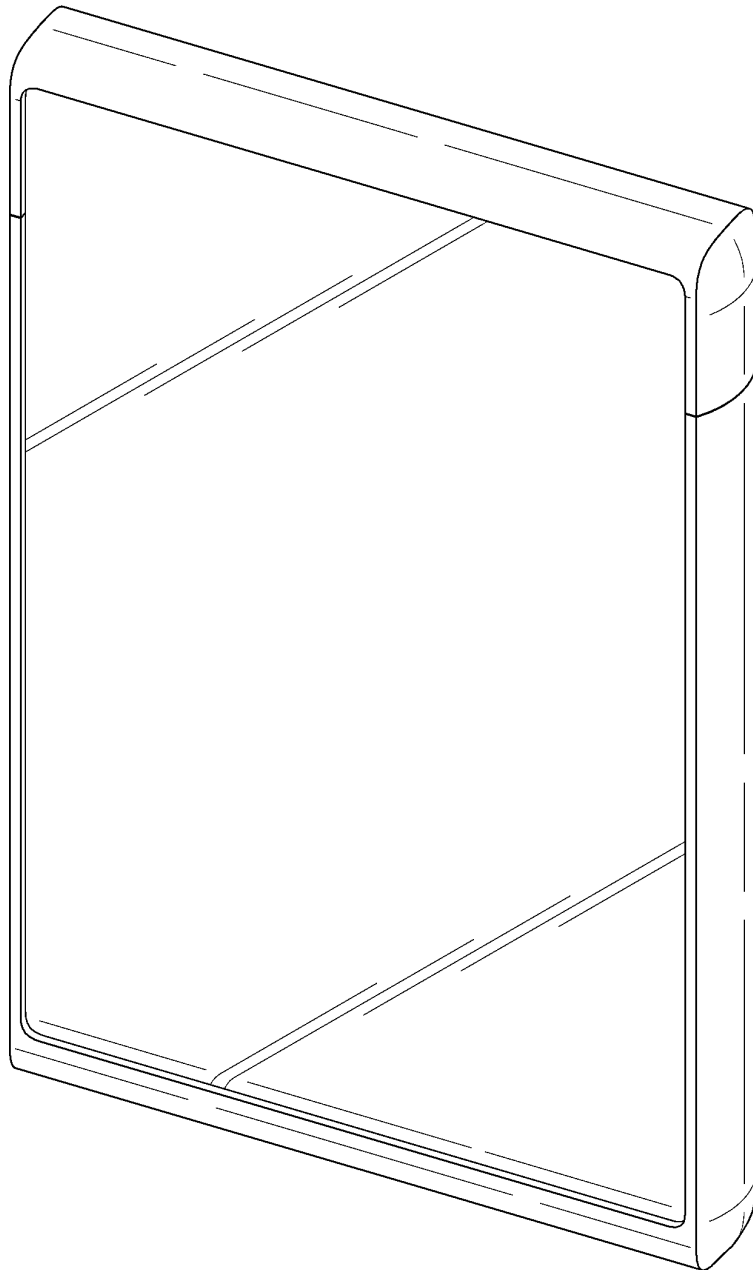

FIG.2

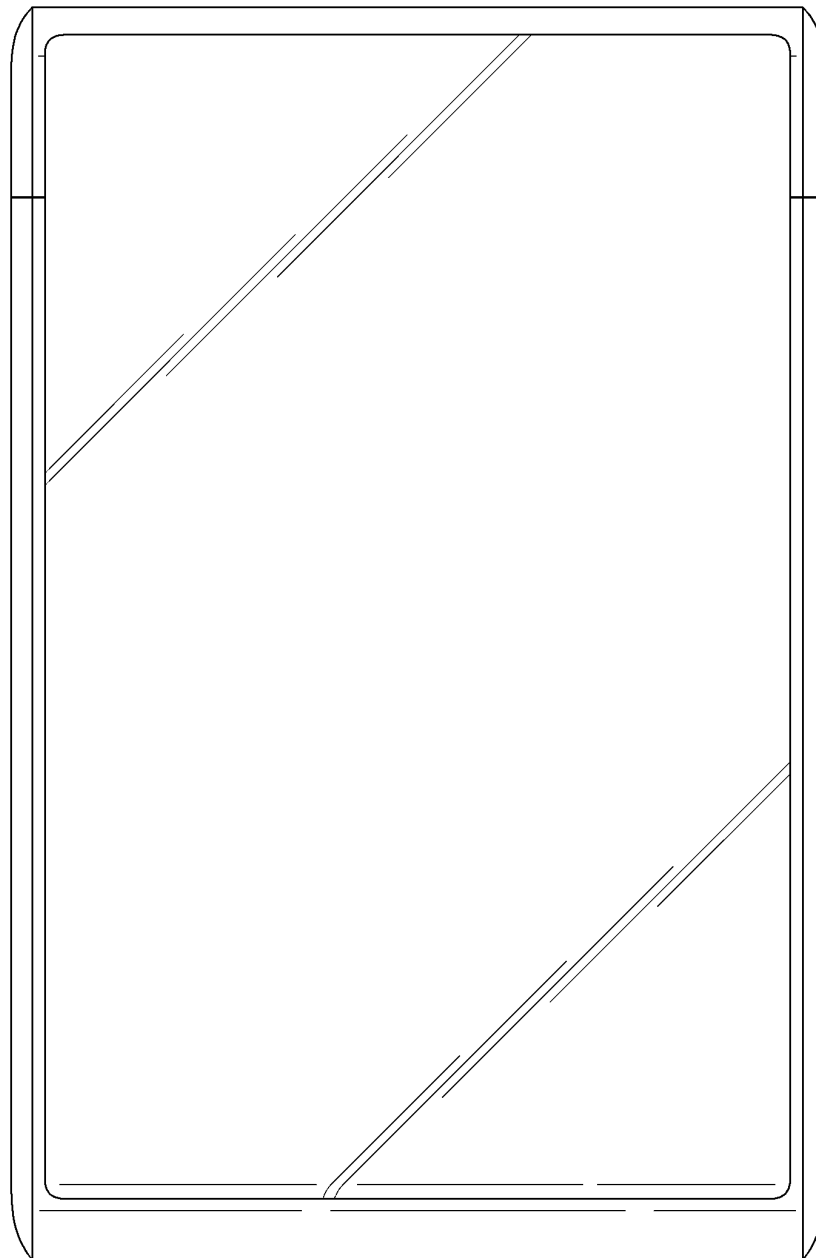

FIG.3

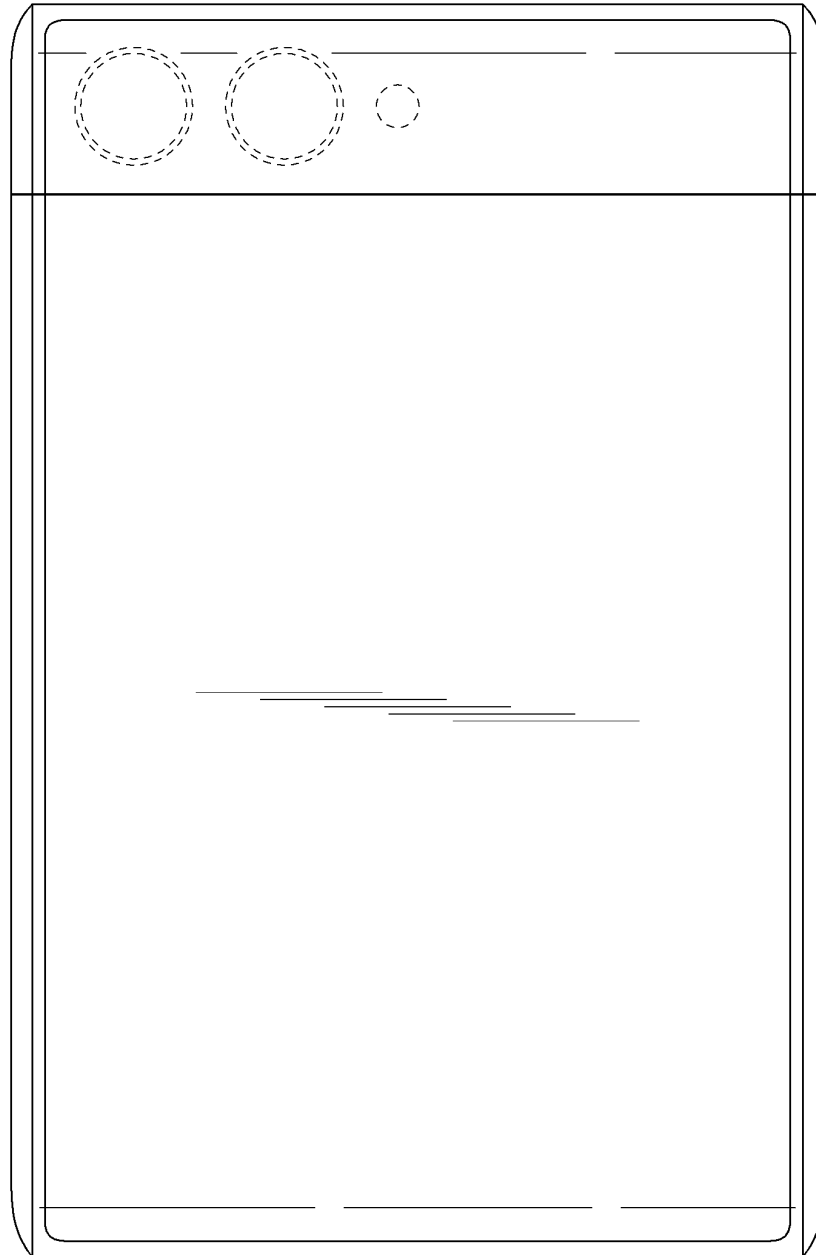

FIG.4

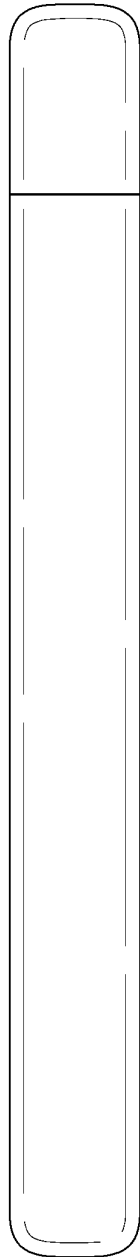

FIG.5

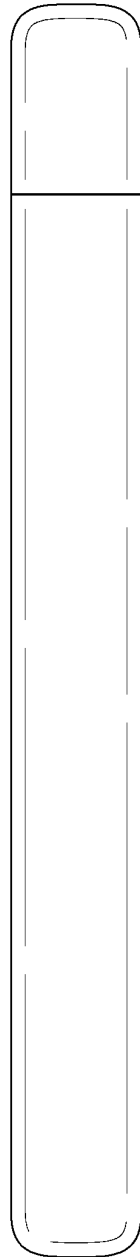

FIG.6

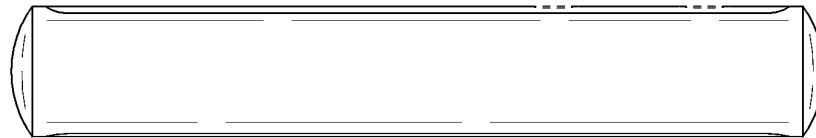

FIG.7

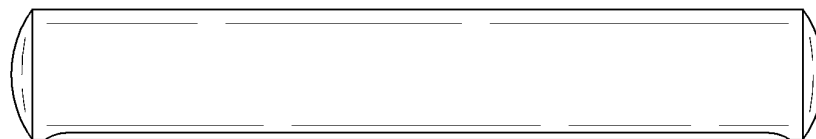

FIG.8

